



# CITY

60025



**WARNING: CHOKING HAZARD.**  
Small parts. Not for children under 3 years.





**AVERTISSEMENT : RISQUE D'ÉTOUFFEMENT.**  
Contient des petites pièces. Ne convient pas aux enfants de moins de 3 ans.



**ADVERTENCIA: PELIGRO DE ASFIXIA.**  
No recomendado para niños menores de 3 años. Contiene piezas pequeñas.

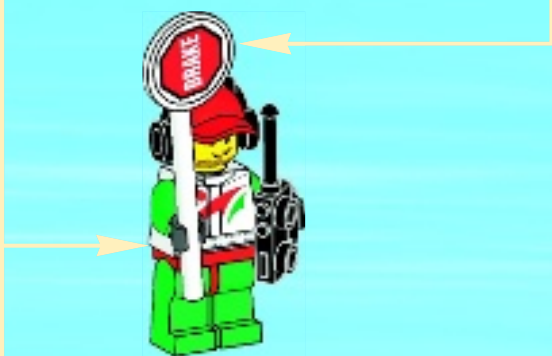
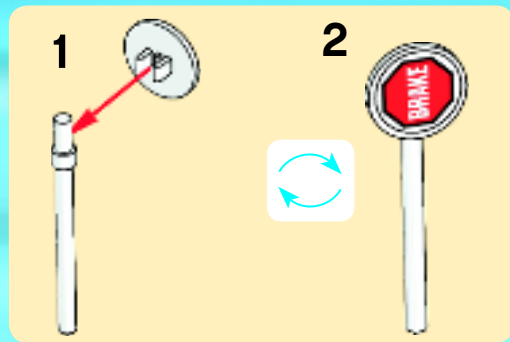

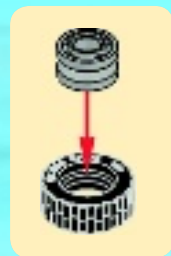





1x

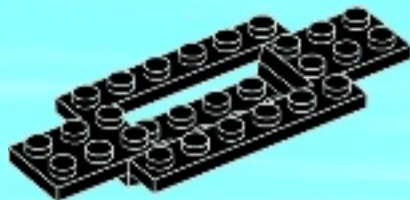

1





1x



1x

2

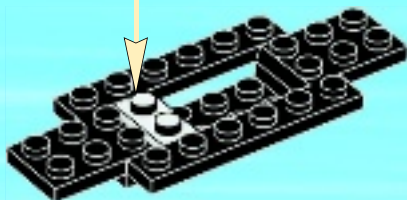
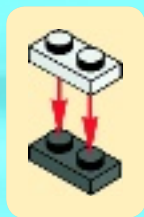





2x

3

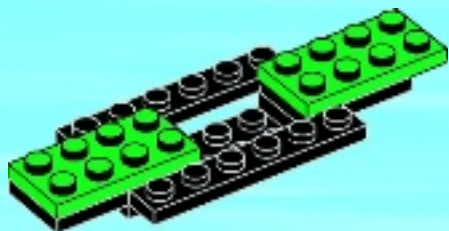

2x

4

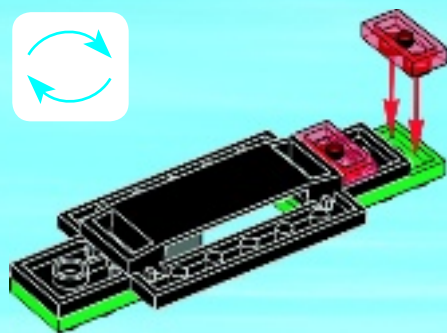





1x

6

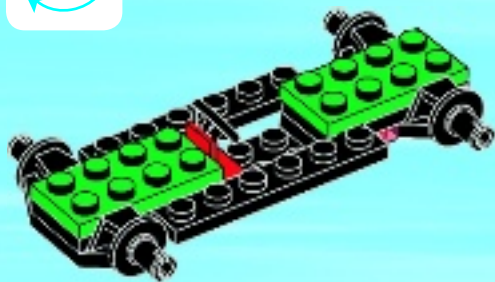

1x



1x

7

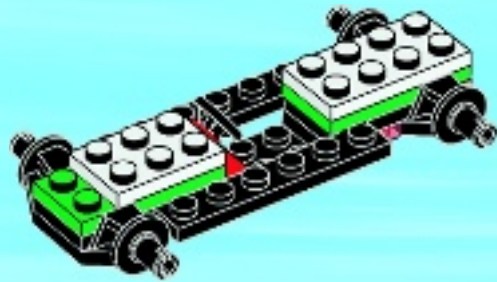



2x

8



2x

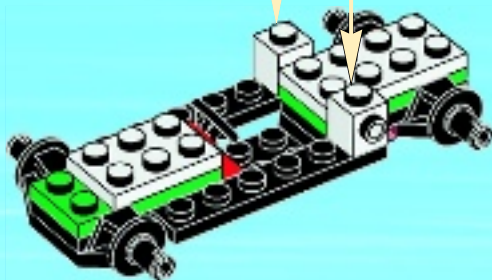



1x



2x

# 9

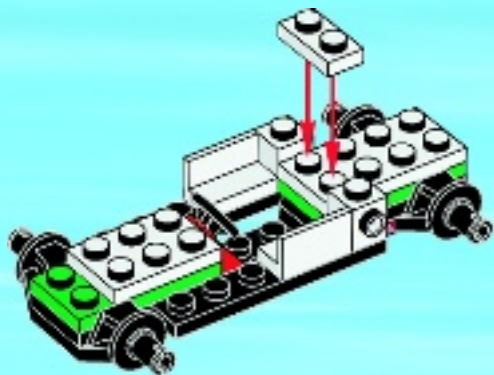

2x

# 10



2x

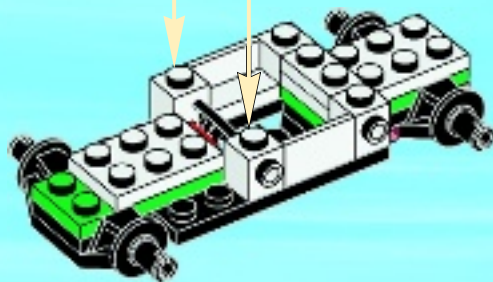



2x

11

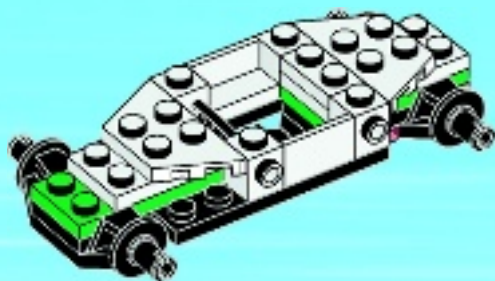



2x



2x

1



2

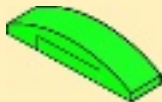

3



2x

# 12







1x



2x

# 13



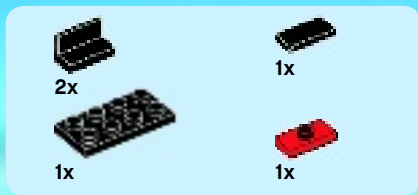

# 14

1



2



3



4



5

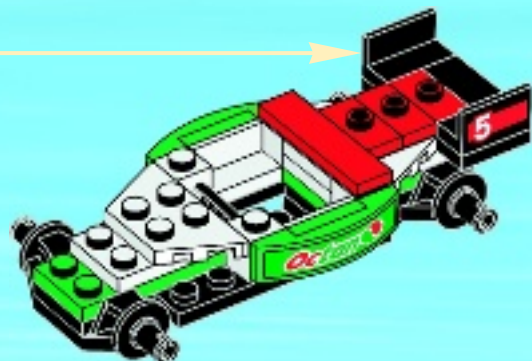
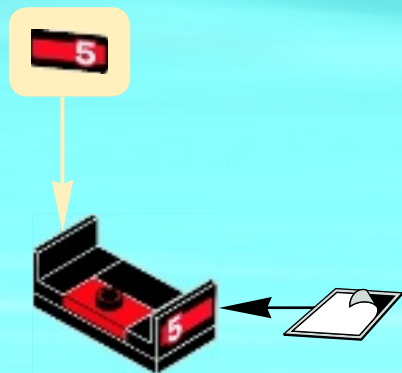



1x



1x



1x

# 15

1



2



3

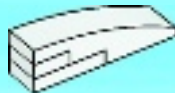

4

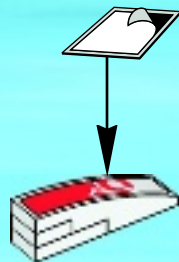

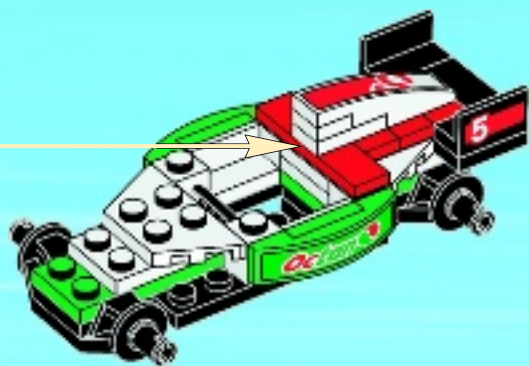

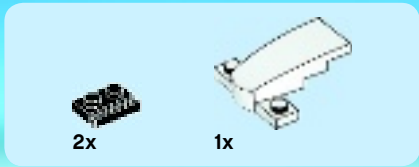

# 16

1

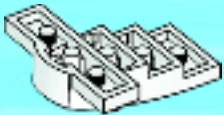

2

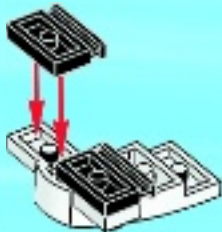

3

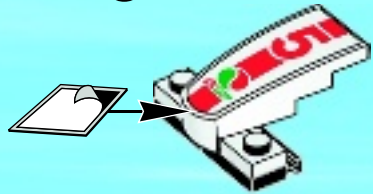







1x

17





4x

# 18

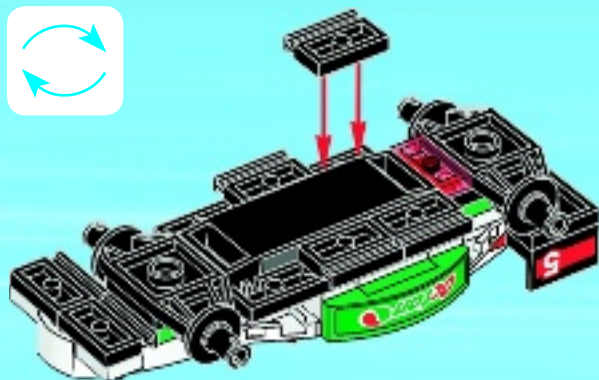



4x



4x

# 19

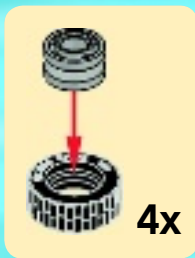

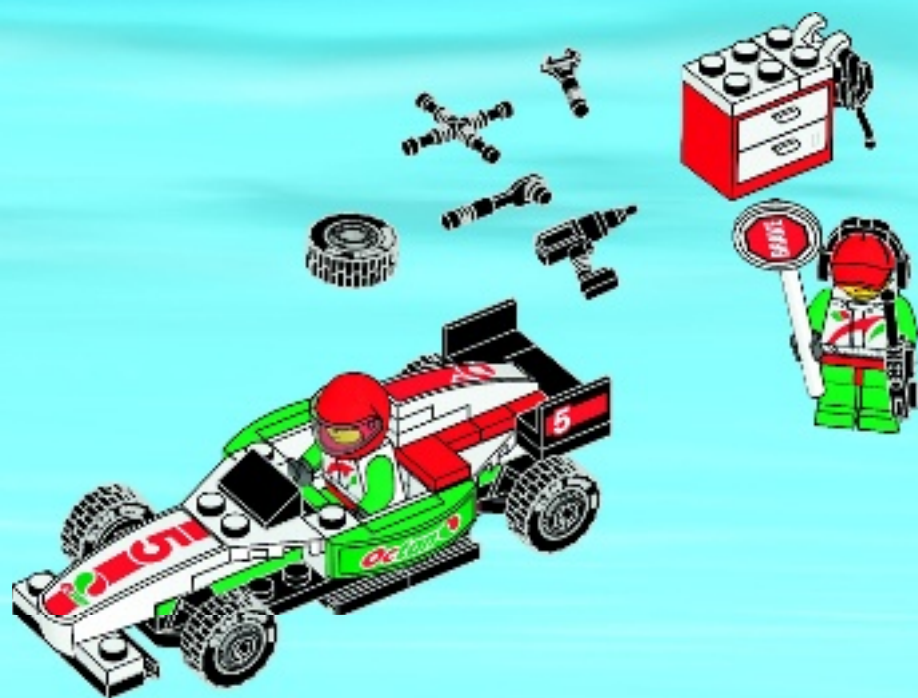

Nintendo



**CITY**  
UNDERCOVER



Game and system sold separately/Le jeu et le système sont vendus séparément. ©2013 The LEGO Group.  
™ & © Warner Bros. Entertainment Inc. (s13). Wii U is a trademark of/est une marque déposée de Nintendo. © 2013 Nintendo.





# WIN!

Go to [www.LEGOsurvey.com/product](http://www.LEGOsurvey.com/product) to fill out a survey for a chance to win a cool LEGO® Product.

No purchase necessary.

Open to all residents where not prohibited.



## [www.LEGOsurvey.com/product](http://www.LEGOsurvey.com/product)

### GEWINNE!

Nimm an der Umfrage auf [www.LEGOsurvey.com/product](http://www.LEGOsurvey.com/product) teil und hab die Chance ein cooles LEGO® Produkt zu gewinnen!

Die Teilnahme am Gewinnspiel führt zu keinerlei Kaufverpflichtungen. Teilnahme in allen nicht ausgeschlossenen Ländern möglich.

### WIN!

Ga naar [www.LEGOsurvey.com/product](http://www.LEGOsurvey.com/product), vul een enquêteformulier in en maak kans op een cool LEGO® product.

Geen aankoopverplichting. Iedereen mag deelnemen, uitgezonderd ingezetenden van landen waar een enquêteverbod geldt.

### GAGNE!

Visite [www.LEGOsurvey.com/product](http://www.LEGOsurvey.com/product) pour répondre à un questionnaire et avoir une chance de gagner un produit LEGO® très cool!

Aucune obligation d'achat. Ouvert à tous les résidents des pays autorisés.

### 当てよう!

[www.LEGOsurvey.com/product](http://www.LEGOsurvey.com/product) にアクセスして、アンケートにご記入ください。当選者にはレゴ®製品を差し上げます。

お買い上げの必要はありません。禁止されていない限り、すべての皆様にご利用いただけます。



LEGO.com

6048878

LEGO and the LEGO logo are trademarks of the/son des marques de commerce de/son marcas registradas de LEGO Group. ©2013 The LEGO Group.